

**COOL  
LIKE  
ICE**



**LEO  
CARLSSON  
#91**



## TABLE OF CONTENTS

- 2 COOL LIKE ICE
- 5 THE STATE THAT MATTERS
- 11 BEAT THE HEAT
- 15 BENEATH THE SURFACE
- 19 BENEATH THE EARTH'S SURFACE
- 20 SLIDE SCIENCE
- 25 HOCKEY HOMEWORK
- 28 FIRST FLIGHT  
FIELD TRIP  
SOUVENIR  
ORDER FORM

This book is dedicated to Jonah Hwang and Joseph Hwang, Super heroes of science.

© 2025 Anaheim Ducks. All rights reserved. Reproduction in whole or in part without written permission from Anaheim Ducks is expressly prohibited.







# COOL LIKE ICE

Hockey fans are the best fans in the world! That's because they know every detail about the teams they root for. Ask any Ducks fan and they can tell you all the stats about my teammates, like Troy Terry and Radko Gudas. They can name all the players who scored in last night's game and even tell you how they did it. Now that's dedication! But there's one fact our fans always seem to forget. There's another team that also deserves to be in the spotlight for the amazing things they do for the sport. Who are they? They're the ice engineers of course!

This talented team builds and maintains the ice rink for arenas across the National Hockey League. So, just how important are they to hockey players? It's quite simple. Without them, we wouldn't be able to play this sport at all. They're the reason the Ducks can pass, shoot, and score goals. They can create the very best sheet of ice even when the weather isn't great. I can't imagine how hockey in Southern California could exist without them.

It's time to bring the science of ice engineers front and center...by making you one! Nervous? Don't worry, you won't be alone. This workbook, along with my teammates and I, will be your guide. You'll be making ice like a pro in no time!

The First Flight Field Trip isn't going to be like any other field trip you've ever experienced. It's going to take some serious effort to work through all these challenging activities. When it comes to hockey, the greatest goals we score are the ones that come after hard work and perseverance.

Try your best and you'll feel just as much excitement finishing this workbook as we do after scoring a goal at Honda Center!

**ARE YOU READY TO BECOME "COOL LIKE ICE"?**

***Let's build your first rink together!***

# COOL LIKE ICE

## A RINK STORY

*The hockey rink has changed a lot throughout the years.*

Watching hockey at Honda Center is an unforgettable experience for anyone, whether they've been a long-time fan or they're new to the sport. It's also one of the most exciting things you can do in Southern California. Where else can you witness the speed and athleticism of hockey players or celebrate with 17,000 other fans after a Ducks goal? However, it's quite easy to take this sport for granted and forget there was a time when we couldn't enjoy this game in person. We didn't always have the technology to make ice rinks or the equipment needed to prevent them from melting.

I'm still cold!

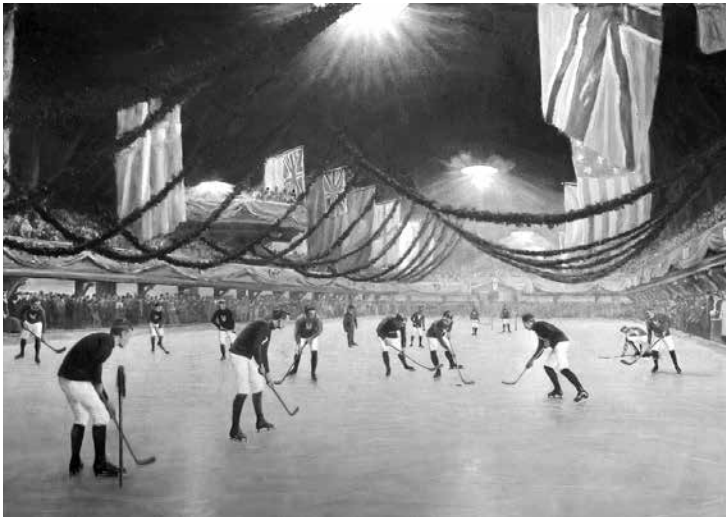

Long ago, hockey only existed in the cold climate regions of the world or in altitudes where snow fell often and where ice naturally formed. Nature provided extremely frigid temperatures that turned natural bodies of water such as ponds and lakes into frozen surfaces people could skate on. Hockey was played outdoors for many centuries, and it wasn't until 1862, that indoor skating rinks were built. These indoor ice surfaces were artificial, meaning that they were made by people. Then, in 1875, the Victoria Ice Rink in Montreal did something remarkable. They hosted the first ever hockey game played on an indoor ice rink. This was a great advancement for the time. However, the technology back then was very simple. Ice engineers still needed to depend on nature to help keep the sheet of ice cold. Hockey remained a winter sport because ice rinks could not be built during warmer months.

In the 1900s, engineers improved their understanding of temperature and the science behind it. This knowledge, also called thermodynamics, paved the way for ice rinks to be built in other regions of the world, making their way throughout Western Canada and then heading south into the northern regions of the United States. A few decades later, the technology for refrigeration systems improved and ice surfaces could be kept cold enough without nature's help. They could also be made in large buildings and arenas holding thousands of hockey fans. Thanks to the hard work and dedication of ice engineers, the sport of hockey is global and can be played year-round. Ice rinks are not limited to certain regions or climate types anymore. They can be made anywhere and anyplace, even in outdoor shopping centers in Southern California. Today, the process for making ice for a hockey rink or ice cubes for a glass of water is similar. You certainly don't need some "frozen" form of magic to make them. All you need is a "Cool Like Ice" attitude, some tools, and science!





# COOL LIKE ICE

## ENGINEERING DESIGN PROCESS

The **engineering design process** is another tool engineers use to accomplish their tasks and improve upon the things they use daily. Read about this design process below and fill in the stack of ice cubes to the best of your ability. Come back to this page often because it will give you some guidance, especially as you make your ice rink.

### 1. ASK A QUESTION

Thinking big always starts with a big question. **What problem do you want to solve or what object do you want to build and improve upon?**

### 2. GATHER INFORMATION

You don't need to memorize every fact or formula. Instead, what's important is how you research and use the information that's out there. **Where are you going to look?**

### 3. BRAINSTORM AND PLAN

Work alone or with a large group to create a list of ideas and supplies you'll need to answer the question. **What ideas do you have in your head?**

### 4. BUILD, TEST, & REDESIGN

Make your best ideas and solutions come to life! Create a model and see if it accomplishes the task that you set out to do. If it doesn't, don't worry, even the best engineers have to go back to the drawing board. **How will you build, test, and improve your design?**

### 5. SHARE!

Don't keep that design a secret! Imagine a world where no one shared their ideas. There wouldn't be life-saving medical equipment or spacecraft to explore the universe. **How will you share your work with others?**

1

How do you  
make an  
ice rink?

2

3

4

5



Share your "Cool Like Ice" photos and videos on social media and tag us @ducksscore



# COOL LIKE ICE



## JOURNAL

Engineers, even ones who build ice rinks, use journals or notebooks to record all their ideas, collect data, and calculations to read them again later. Each time you see this icon, jot down some notes or any observations about ice in your journal. If you like to doodle, drawing plans and diagrams are encouraged!

## PENCIL & ERASER

Engineers and scientists like to take notes that are very neat. That's why they use pencils and erasers for the best results. It's important to keep your ideas or notes, no matter how wild and crazy they are. Erase mistakes, not ideas!

**DON'T HAVE A JOURNAL?**  
**Scan the QR CODE and find the JOURNAL PROJECT**  
**to learn how to make one.**



## HERE ARE THE FIRST "TOOLS" YOU'LL NEED TO BECOME COOL LIKE ICE!

Ice engineers are people who know what "Cool Like Ice" means. That's why it's important for you to know who they are and what they do. In general, **engineers** are the people who design, create, and build things that help us each day. That chair you're sitting on? It was designed by a **structural engineer**. Like to play video games? They were programmed by a **software engineer**. The car that took you to school? It was built by **mechanical engineers**. We're fortunate there are many types of engineers who answer the call to make our lives better! In the case of **ice engineers**, these people understand the science behind ice so that they can make the coldest, smoothest, and hardest ice surface for the fastest game in the world. That's what it means to be "Cool Like Ice"!

## COACHES CHALLENGE

Ice engineers, including those at Honda Center, are responsible for building the ice rink every September, right before the start of the National Hockey League season. It's a good thing they have many tools and equipment to help them accomplish this task. What do you think each of these tools are used for when building and maintaining an ice rink for the Ducks?



Water Hose and Spray \_\_\_\_\_  
 \_\_\_\_\_

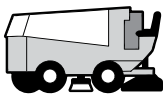

Ice Resurfacing Machine \_\_\_\_\_  
 \_\_\_\_\_



Thermometer \_\_\_\_\_  
 \_\_\_\_\_

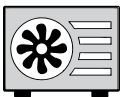

Air Conditioning System \_\_\_\_\_  
 \_\_\_\_\_



Shovels \_\_\_\_\_  
 \_\_\_\_\_

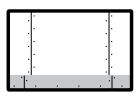

Rink Boards \_\_\_\_\_  
 \_\_\_\_\_

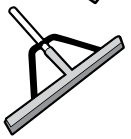

Squeegee \_\_\_\_\_  
 \_\_\_\_\_

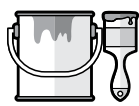

Paint \_\_\_\_\_  
 \_\_\_\_\_

**Great job! Here are the first "tools" you'll need to become "Cool Like Ice!"**



# THE STATE THAT MATTERS

While most people see ice as simply the frozen form of water, ice engineers must look at it in an entirely different way. They must look at ice very closely. But before we zoom in, let's zoom out and take a look at your surroundings. Go ahead, look around! If you were at Honda Center for a hockey game, you might see players, Wild Wing, fans cheering, and the ice rink itself. These things are called matter. **Matter** is anything that takes up space and has weight. It is all the stuff that you can see and even the things you can't see. Matter is everywhere!

Matter explains how objects on Earth and in the universe behave. They can be found in different forms, or **states**, called **solids**, **liquids**, and **gases**. Each of these states are unique in the way they look, feel, and work. For instance, ice is an object solid enough to be used for skating where liquids and gases are not. Just imagine what would happen if you tried to skate on a liquid, like water!

**SOLID**  
A **solid** is hard and holds its shape. Ice is the solid form of water.

**LIQUID**  
A **liquid** is fluid and takes the shape of a container from the bottom up. Water is the liquid form of ice and steam.

**GAS**  
A **gas** expands outwardly with energy and explosiveness. Steam is the gaseous form of water and ice.

## COACHES CHALLENGE

What objects do you see in the picture below? In your journal, write down all matter that you see (or can't see) for this states of matter scavenger hunt at Honda Center. Be sure to identify them with one of the following states – solid, liquid, or gas.

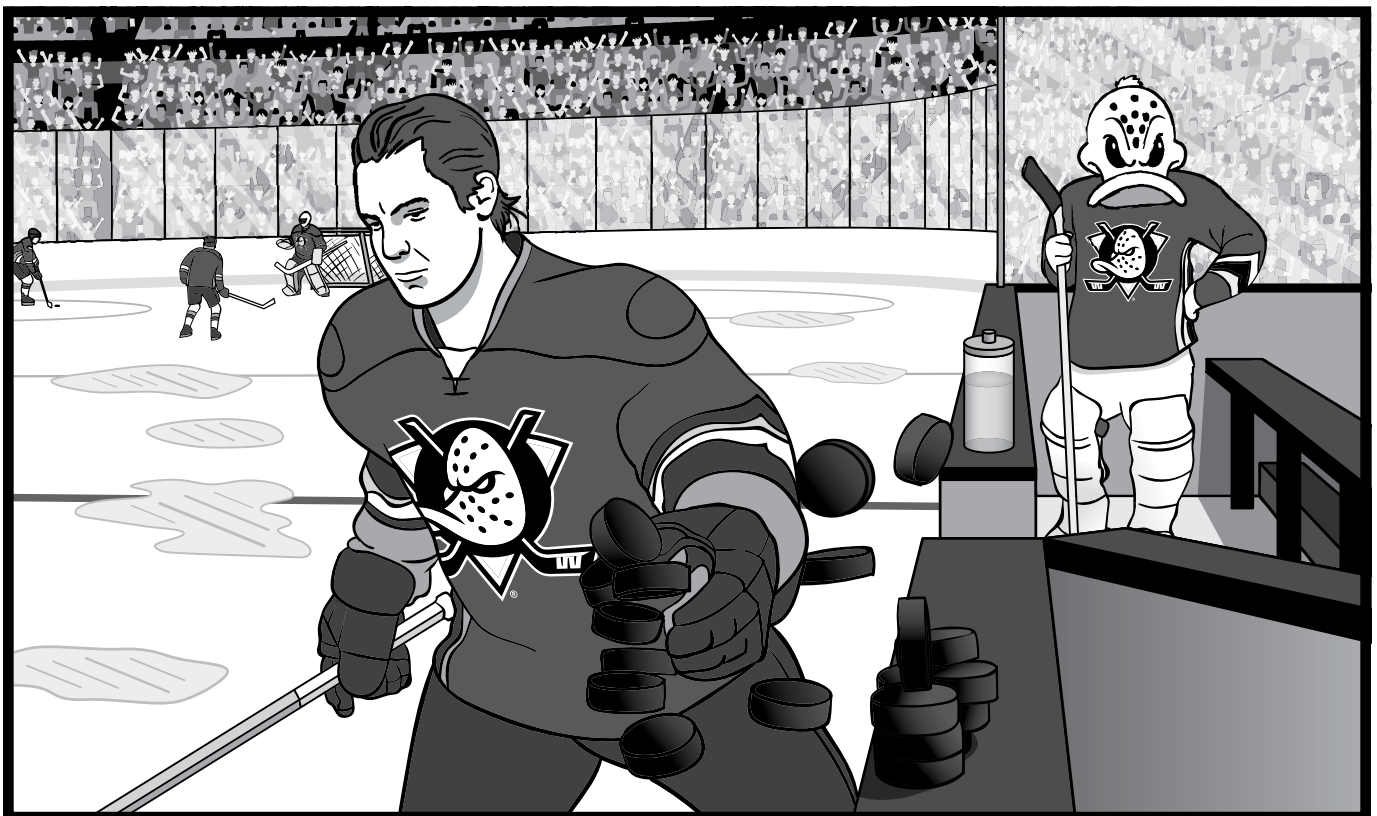



# THE STATE THAT MATTERS

On a hockey rink, players are everywhere! For anyone watching this fast-paced game, it can be quite a challenge to keep track of all these players as they skate on the ice or jump over the solid boards to replace their “gassed” teammates. It’s a good thing hockey players share something in common with matter. They come in different states too! These states, or **positions**, are called **forwards**, **defensemen**, and **goalies**. Each of these positions are unique in the way they look and work. Let’s explore the different positions to see what they do for a hockey team like the Anaheim Ducks.

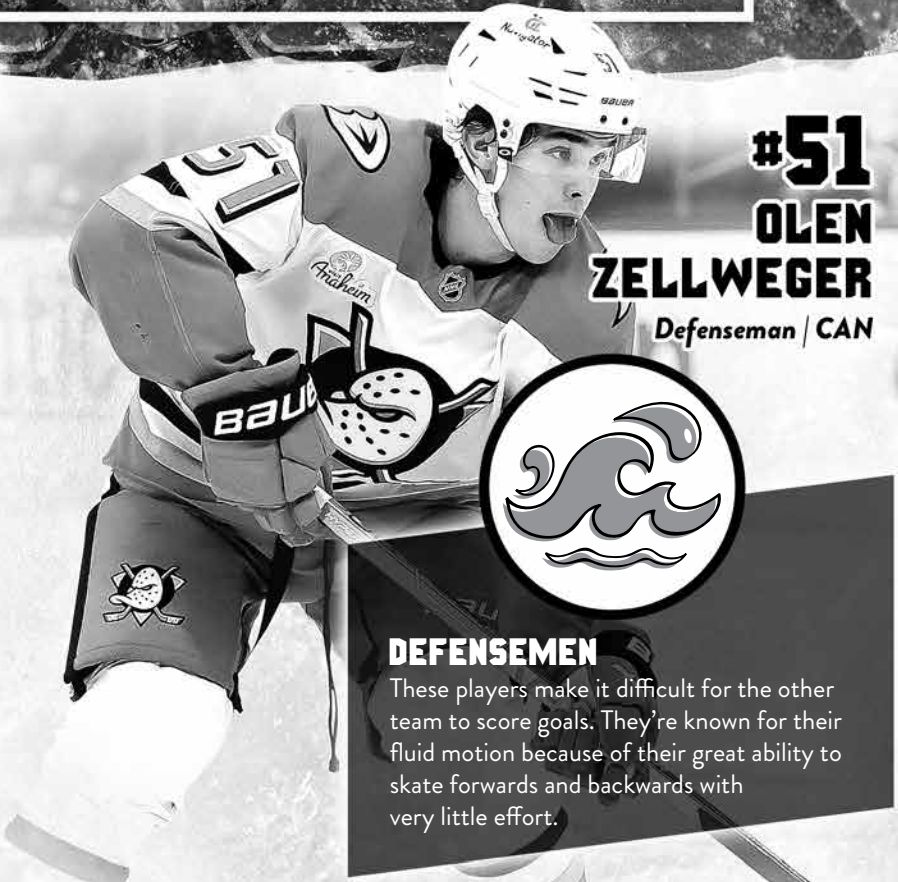

**#51**  
**OLEN**  
**ZELLWEGER**  
Defenseman | CAN

**DEFENSEMEN**  
These players make it difficult for the other team to score goals. They’re known for their fluid motion because of their great ability to skate forwards and backwards with very little effort.



**CAM FOWLER**  
Defenseman | USA



**BRIAN DUMOULIN**  
Defenseman | USA



**RADKO GUDAS**  
Defenseman | CZE



**TREVOR ZEGRAS**  
Forward | USA



**ROBBY FABBRI**  
Forward | CAN



**RYAN STROME**  
Forward | CAN



**ALEX KILLORN**  
Forward | CAN

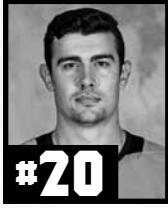

**BRETT LEASON**  
Forward | CAN

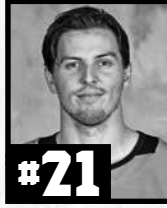

**ISAC LUNDESTROM**  
Forward | SWE



**MASON MCTAVISH**  
Forward | USA



**PAVEL MINTYUKOV**  
Defenseman | RUS



**DAISY TEAM DOG**  
USA





# THE STATE THAT MATTERS



**#19 TROY TERRY**  
Forward | USA

**#1 LUKAS DOSTAL**  
Goalie | CZE

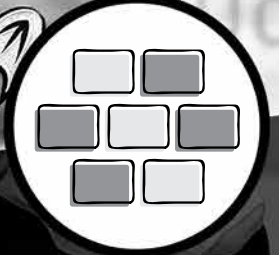

**GOALIES**  
These players are responsible for keeping the puck out of their net. They do this by playing big and tall like a solid wall.



**FORWARDS**  
These players use their explosive movement to score goals. With their speed, they chase pucks, generate great scoring chances, and spread out to cover much of the hockey rink.



**JOHN GIBSON**  
Goalie | USA



**ROSS JOHNSTON**  
Forward | CAN



**JACKSON LACOMBE**  
Defenseman | USA



**CUTTER GAUTHIER**  
Forward | USA



**JACOB TROUBA**  
Defenseman | USA



**FRANK VATRANO**  
Forward | USA

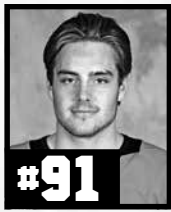

**LEO CARLSSON**  
Forward | SWE





# THE STATE THAT MATTERS

## THE WAY YOU MOVE

You know that matter comes in three different states. But, did you know that it can change states too? In some instances, it can do this right before your very eyes! Matter has a “super power” like ability to change states because it’s made of tiny things called atoms. **Atoms** are the building blocks of life and like your block set, they can be combined with one another to form **molecules**. Ice is made when two hydrogen atoms and one oxygen atom combine. You might know this water molecule by its nickname. It’s H<sub>2</sub>O!

Matter is filled with millions or even billions of molecules and it’s their movement that causes solids, liquids, and gases to change from state to state. Molecules move in three different ways. For solids, they are fixed in place. Their molecules don’t move around at all. But once they start moving, solids become liquids. At very fast speeds, matter transforms into gases because their molecules are moving with tons of energy. The picture below shows the relationship between the movement of molecules and their state of matter.

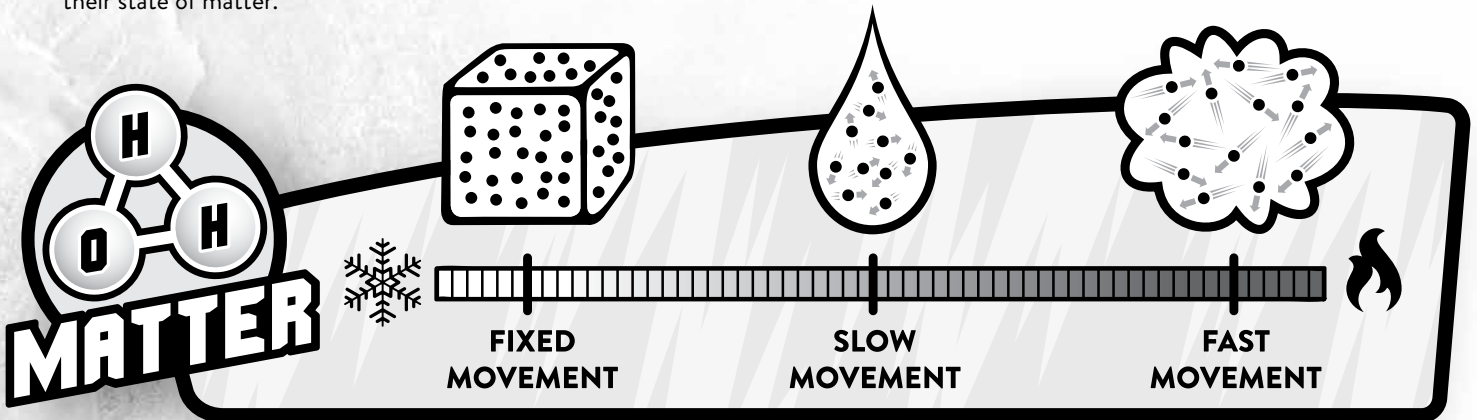
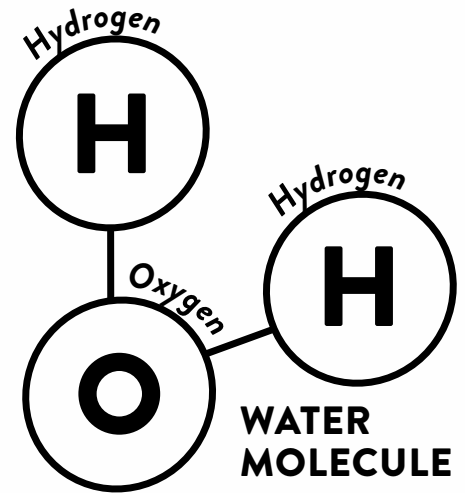

If you’ve ever held a piece of ice in your hand, it probably didn’t take long for you to drop this very cold object. So, what makes ice cold? We can understand this frosty word by doing our best impression of a molecule. That’s because the human body has three states of activity that resemble the movement of molecules in the three states of matter. **Sedentary activities** are ones where the body is fixed in place, like sitting. But once the body starts moving, it becomes **moderately active**. When it is very **active**, the body moves with lots of energy and speed.

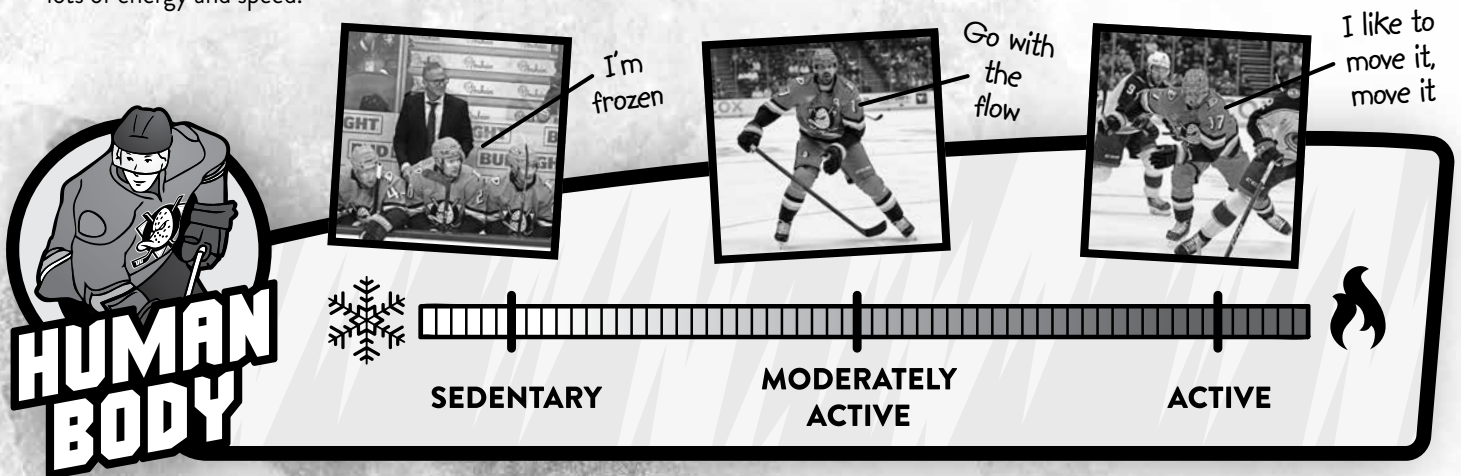



# THE STATE THAT MATTERS



Are you ready to get moving? To find the real meaning of cold, pay attention to how you feel after participating in each of the three states of activity. It will reveal what happens to molecules as they begin to move and cause an object, like ice, to change states from a frosty solid into an explosive cloud of steam. **Grab a partner and let's get moving!**

## STEP 1

### GATHER MATERIALS

- Pencil
- Stopwatch, timer, or clock
- You!

## STEP 2

### LET'S MOVE!

- **Plan** your activities with the three states of activity in mind. Write them down in Column A and then complete these activities for at least five minutes each.
- **Describe** how you felt after each activity using the space provided in Column B.
- **Circle** a number on the scale in Column C to describe the amount of heat you felt during each activity.

### Data Collection

	State	Activity (A)	Feeling (B)	Heat Produced (C)
1	Sedentary			0 1 2 3 4 5 6 7 8 9 10
2	Moderately Active			0 1 2 3 4 5 6 7 8 9 10
3	Active			0 1 2 3 4 5 6 7 8 9 10

## STEP 3

### ANALYZE YOUR DATA

A. Complete the bar graph for the heat produced during each of the three states of activity.

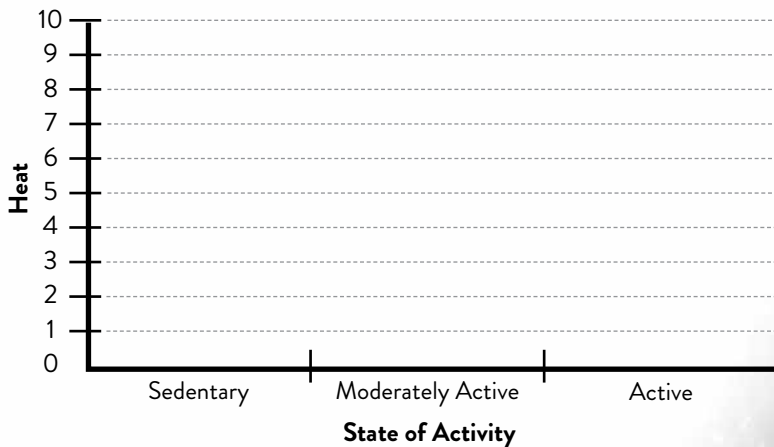

B. What does this graph tell you about the body when it moves?

---



---



---

*Man! It's hard to aim these moderately active molecules.*





# THE STATE THAT MATTERS

I know!  
Pick me! —



## CONCLUSIONS

A. Knowing that the human body and molecules are similar when they move, what do you think happens to molecules when they increase their movement and speed?

---

---

---

B. Complete the sentences below using your knowledge of heat and the states of matter. Use the words “more” or “less” to finish the sentence.

- A solid contains \_\_\_\_\_ heat than its liquid form.
- A solid contains \_\_\_\_\_ heat than its gas form.

C. What does the word “cold” mean when we talk about the amount of heat a solid piece of ice has? This is the real definition of cold! (**HINT:** How much heat did you make and feel when you were sedentary?)

---

---

---



Look around you. Write down two types of gases, liquids, and solids in the space you are in.



# BEAT THE HEAT



## COOL IT!

People who come to Honda Center to watch a Ducks game are often shocked by how cold it is inside the arena. At a frosty temperature of  $14^{\circ}\text{C}$ , it keeps the ice cold and rock solid so that the Ducks can play their exciting style of hockey against their opponents. However, the guys wearing the other jerseys aren't the only opponents the Ducks must face each night. It's heat!

**Heat** is a form of energy we can easily feel on a hot summer day or when sitting around a campfire. But, did you know that heat is always present, even when things are cold? Instead of using our sense of touch and words like "hot," "warm," and "cool," **temperature** describes heat accurately with numbers. There are many ways to measure temperature but Celsius is the preferred choice of scientists in most parts of the world and ice engineers everywhere. **Celsius (C)** was made with water's three states in mind. It uses round numbers such as 0 and 100 to define the **freezing point** and **boiling point** for water. By using this scale, you can compare the amount of heat between places or objects. The next time you watch a weather forecast and see that Mammoth, California is a chilly  $-5^{\circ}\text{C}$ , you'll know that the mountain air contains less heat than at the beach, where it's a comfortable  $24^{\circ}\text{C}$ .

### FREEZING POINT

When a liquid turns into a solid. This is when water turns into ice.

### BOILING POINT

When a liquid turns into a gas. This is when water turns into steam.

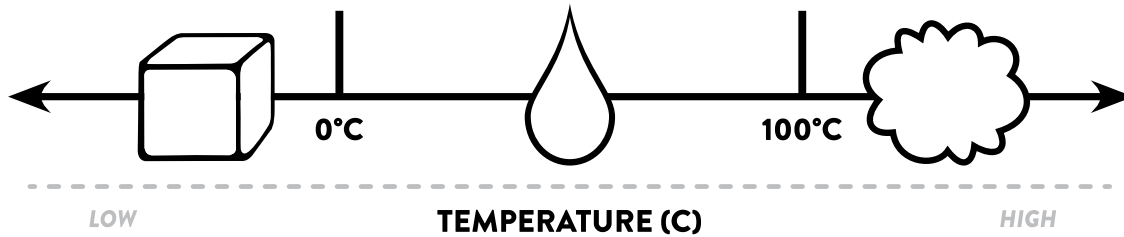

## COACHES CHALLENGE

There are many tools ice engineers use to make the best ice surface for hockey, but none are as important as a **thermometer**. It's a device that measures temperature instantly. Use the thermometer below to plot and compare the temperatures of common objects.

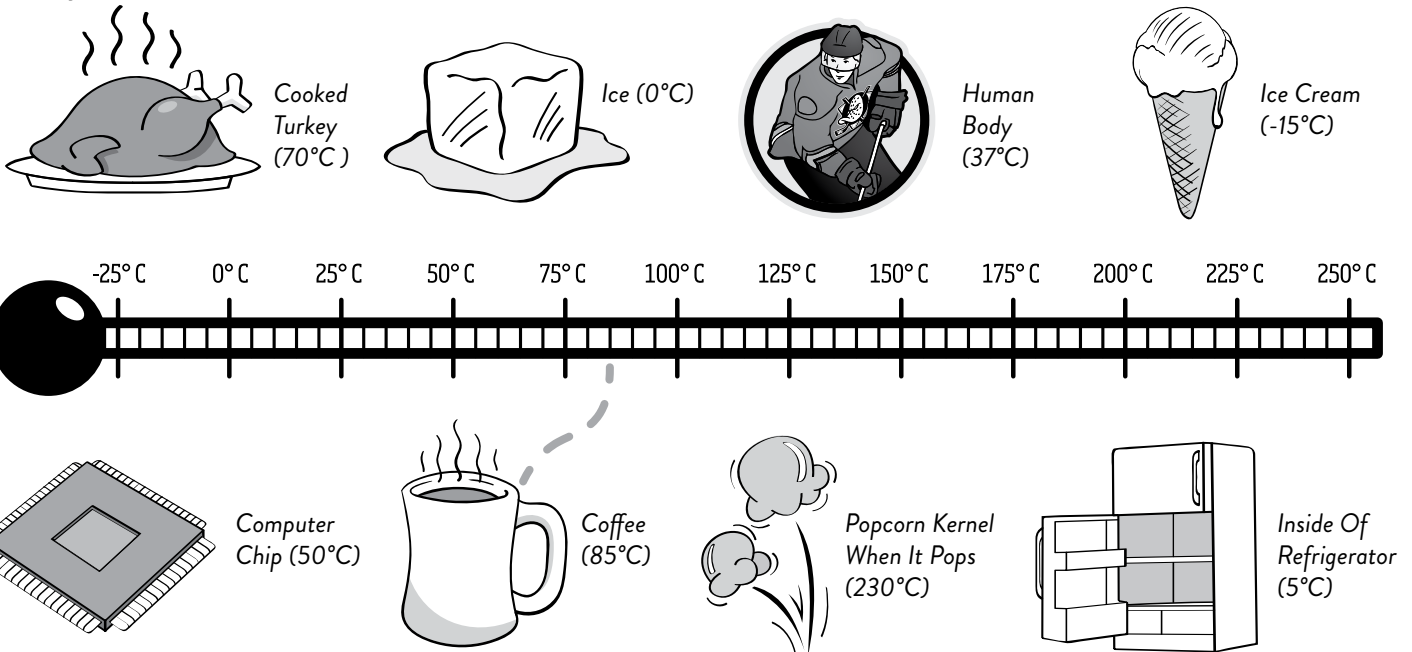



# BEAT THE HEAT



## HOT PASS

Much like playing against a hockey team with a very good offense, trying to beat the heat is a difficult thing to do. That's because heat has the ability to be passed around wherever and whenever it wants to. When the heat from one object is passed, or given, to another object with less heat, it's called **heat transfer**. Also, heat transfer is persistent! It won't stop until everything becomes the same temperature. Have you ever dropped a piece of ice only to find a small, warm, puddle of water later? Since the air and ground contain more heat than the ice cube, it melts and changes into a liquid, thanks to heat transfer.

Let's investigate this concept of heat transfer some more!

If the temperature of A is **MORE THAN** B.



If the temperature of A is **LESS THAN** B.

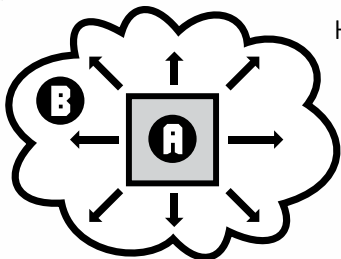

Heat is passed **OUTWARD** until the temperatures of A and B are **EQUAL** to each other.

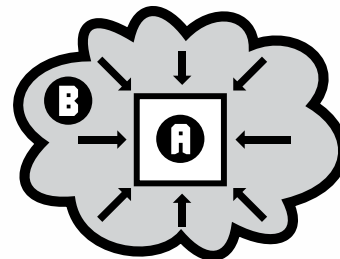

Heat is passed **INWARD** until the temperatures of A and B are **EQUAL** to each other.

## COACHES CHALLENGE

Now that you know how heat transfer works, it's time to look for the objects that make it difficult for ice engineers to keep the ice surface frozen during a Ducks game. Circle all of the things that will pass heat towards the Honda Center ice rink. In your journal, give reasons why ice engineers should be concerned about them.

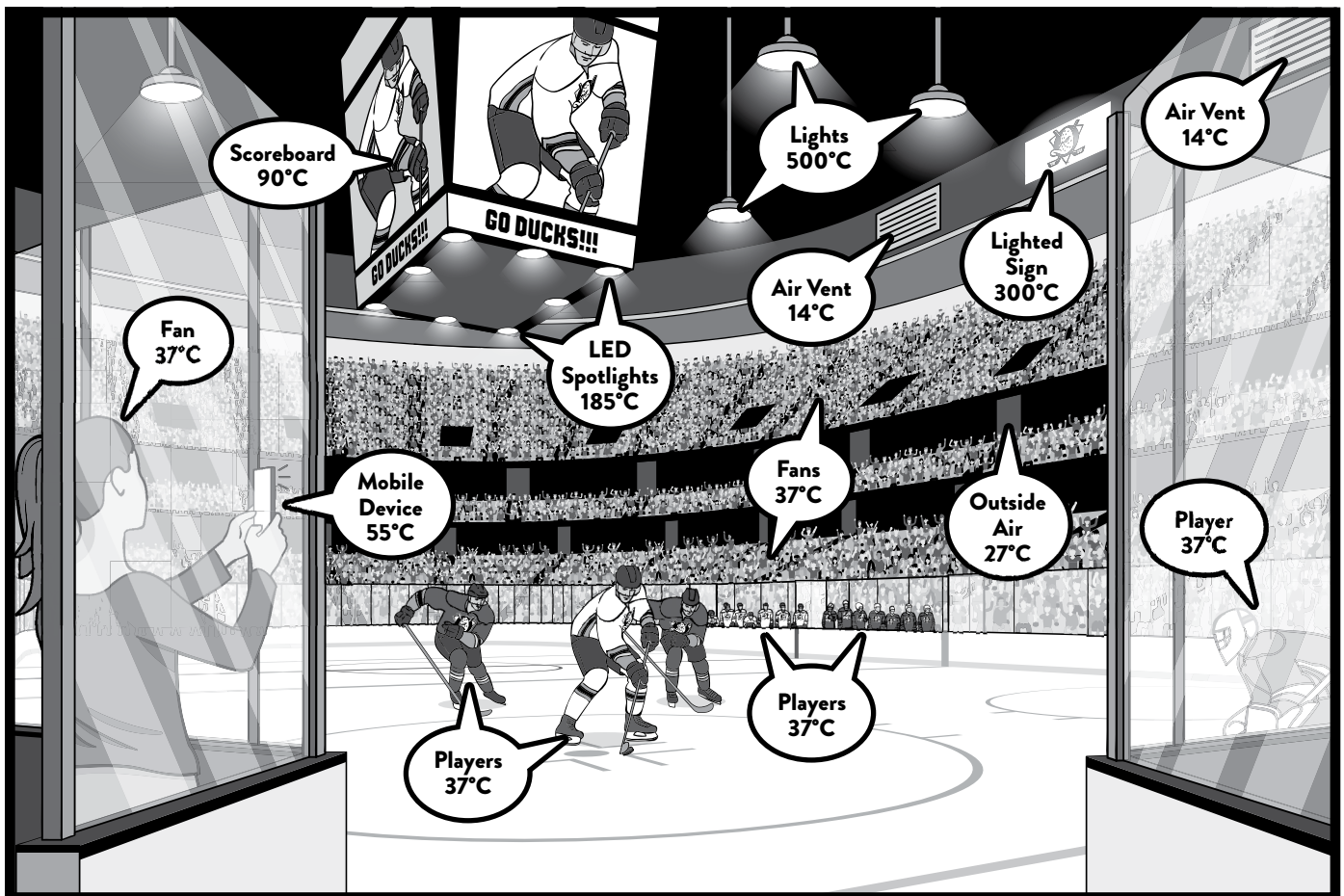



# BEAT THE HEAT

Presented by  
**CHOC**

## HERE'S THE SCOOP

Most objects in this world can melt ice because they contain more heat. When things like hot lights and warm bodies fill a large arena like Honda Center, they make it difficult for ice engineers to do their job well. That's why ice engineers rely on a special tool for help. What's this tool called? It's **heat transfer**! That's right, with science, heat transfer is a loyal teammate who can keep an ice surface frozen all game long.



You don't need to take a trip to Honda Center to see this new teammate in action. For instance, you see it at work each time you use a refrigerator to prevent leftovers from spoiling. There's also a tastier way to experience heat transfer. So, what are you waiting for? Let's make this sweet treat!

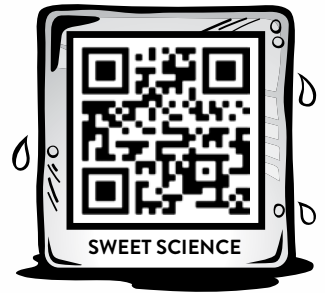

## STEP 1 GATHER MATERIALS

- Two plastic zipper-lock style bags (*One large and one small*)
- Small towel or gloves
- 1/2 cup milk
- 1/2 cup heavy cream
- 1/4 cup white sugar
- 1/2 teaspoon vanilla flavoring or any flavoring
- 1/2 to 3/4 cup table salt
- 2 cups ice
- Measuring cups and spoons

## STEP 2 PREPARE THE SMALL BAG

Add the heavy cream, milk, sugar, and flavoring to the bag. Squeeze the bag to get some of the air out before closing it. Shake the bag lightly to mix the ingredients.

## STEP 3 PREPARE THE LARGE BAG

Add the ice and salt to the bag. Once you seal it, give the bag a good shake to mix the contents.

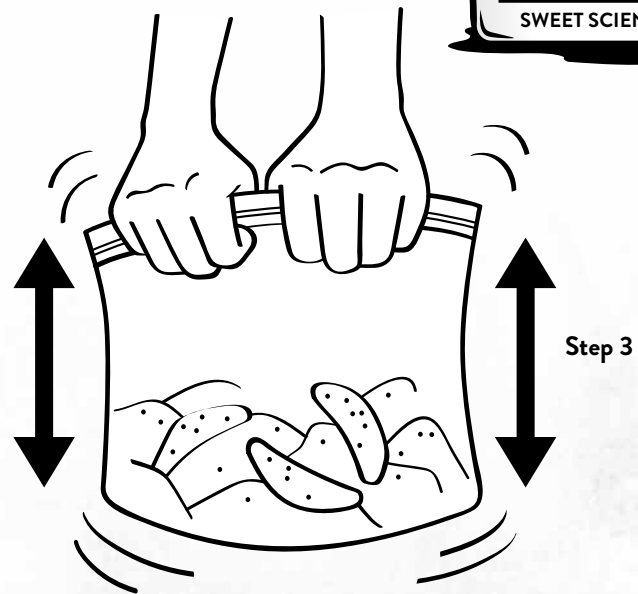

## STEP 4 COMPARE THE BAGS

Place your hand on the bottom of each bag for a few seconds. Use the heat scale in Table A to rate the temperatures of the large and small bags.

## STEP 5 LET'S SHAKE IT!

Place the small bag into the large bag. Once it's zipped closed, wrap the large bag with a towel and start shaking! Keep shaking until the liquid in the small bag starts to turn into a solid. This should take about 15 minutes.

## STEP 6 COMPARE THE BAGS... AGAIN

Remove the small bag from the large bag and place them both on the towel. Feel the bottom of the two bags and rate them again using the heat scale in Table B.

## STEP 7 ENJOY YOUR DESSERT!

What did you make? Open the small bag and serve its contents in a bowl. Enjoy!

Step 5

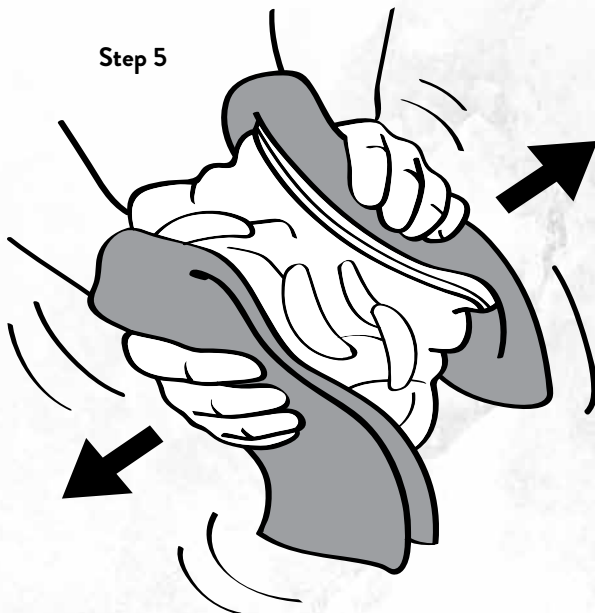

# BEAT THE HEAT



## COLLECT THAT DATA!

Table A: **BEFORE** ice cream is made:

Bag	Contents	Temperature
#1 (Small)		0 1 2 3 4 5 6 7 8 9 10 Very Cold      Cold      Warm
#2 (Large)		0 1 2 3 4 5 6 7 8 9 10 Very Cold      Cold      Warm

Table B: **AFTER** ice cream is made:

Bag	Contents	Temperature
#1 (Small)		0 1 2 3 4 5 6 7 8 9 10 Very Cold      Cold      Warm
#2 (Large)		0 1 2 3 4 5 6 7 8 9 10 Very Cold      Cold      Warm

## CONCLUSIONS

- Use the data from Tables A and B to compare the temperatures of the bags before and after making ice cream. Why did their temperatures change?

---



---

- How did you use heat transfer to make ice cream? (**HINT:** Use the heat transfer diagram on page 12 to help you explain this.)

---



---

- Describe some examples of when heat transfer was your teammate and your opponent.

---



---



---

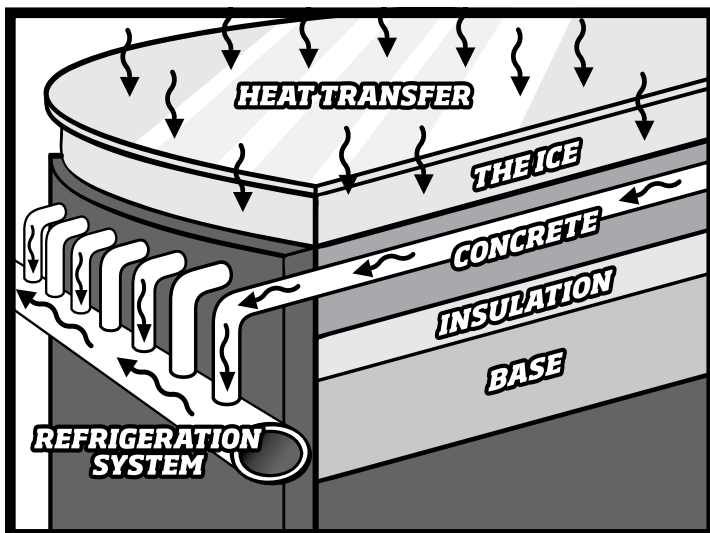
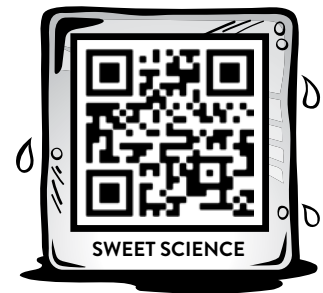

### HONDA CENTER HEAT TRANSFER

The process ice engineers use to preserve the Honda Center ice surface shares a lot of the same science as making ice cream. Passing heat one time, from the small bag to the large bag, might be enough for a bowl of ice cream but keeping a large sheet of ice frozen is much more complicated. It takes three passes between four objects to get the job done. First, heat transfer is used to pass heat from the arena air down to the body of ice. Then, it's passed into the concrete floor. Finally, heat is carried out of the arena through many pipes connected to the refrigeration system. Salt water is pumped through these pipes at a temperature of  $-8^{\circ}\text{C}$ . This is cold enough to keep the ice from melting, even during a Ducks game with more than 17,000 warm bodies in Honda Center.



# BENEATH THE SURFACE

## DRAWING THE LINE

Hockey fans often focus on the action above the ice but it's what underneath that shapes the game. The lines, circles, and logos we see in an ice rink determine the rules for hockey. That's why it's important for ice engineers to make ice that's as clear as a piece of glass. If they don't, how would players know where to line up for the opening face off?



Ice clarity is a difficult challenge for ice engineers. Depending on how it's made, ice can be clear, very cloudy, or anything in between. The best way to see this in person is to examine a piece of ice from a household freezer.

## STEP 1 GET A HOMEMADE PIECE OF ICE

*\*\*If your freezer doesn't have an ice maker, make ice yourself by pouring water into a tray or cup and placing it into a freezer for a few hours.*

## STEP 2 EXAMINE YOUR ICE

Examine the **INSIDE** of the ice cube.  
Write down what you see.

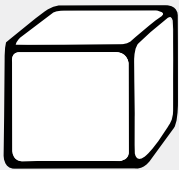

---



---



---

Place the ice cube on top of the Ducks logo.  
Write down what you see (or can't see).



---



---



---

## CONCLUSIONS

1. What are some reasons you believe the Ducks and their fans would not like about using this type of ice for hockey?

---



---

Household freezers turn objects from liquids to solids quickly by surrounding everything inside it with air that's a freezing  $-5^{\circ}\text{C}$ . While this is a great way to make ice cubes, you end up with a cloudy piece of ice. Air bubbles become trapped inside an ice cube when it's made too quickly. So, how do ice engineers get these bubbles out? They have to control the **temperature** to give these air bubbles more **time** to escape!



## STEP 1

### GATHER MATERIALS

- Six Styrofoam Cups
- Tape
- Marker
- Scissors
- Towel
- Water

## STEP 2

Fill two cups 3/4 full with water. Label the cups #1 and #2.

## STEP 3

Stack cup #2 on top of three other Styrofoam cups. There should be a total of four cups stacked.

## STEP 4

For the last cup, cut 1/3 off the top and poke a small hole through the bottom. Flip it over and cover cup #2. Use tape to hold it in place.

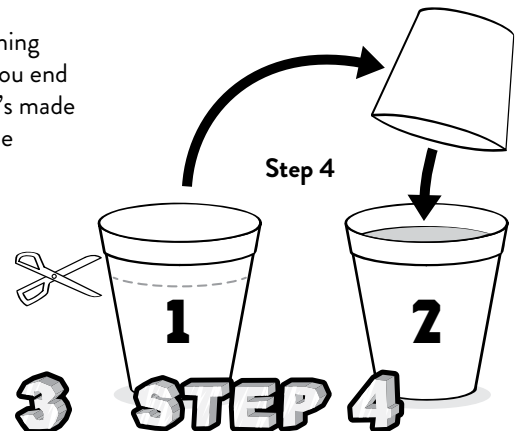

# BENEATH THE SURFACE

**STEP 5** Place cups #1 and #2 into the freezer. Check on the cups after 1, 2, 3, 4, 5, and 10 hours, and record what you see in the chart below. Has the water frozen completely?

	Hour One	Hour Two	Hour Three	Hour Four	Hour Five	Hour Ten
Cup #1						
Cup #2						

**STEP 6** Remove the cups from the freezer. Then, peel the Styrofoam off each cup to get to your piece of ice.

**STEP 7** Give each piece of ice a quick wipe with a wet towel. Place them side-by-side to help you see their differences.

## CONCLUSIONS

1. What does the inside of each piece of ice look like? Write down your observations below.

---



---

2. Why do you think cup #2 produced ice that was clearer than cup #1? (**HINT:** Use your data from Step 5.)

---



---



How would you improve this ice making activity? Use your journal and the engineering design process to come up with some ideas to make clearer ice. Then, go and make it!

Now that you've got the skills to make the clearest ice for hockey, it's time to discover how ice engineers at Honda Center place the lines, circles, and spots inside the body of ice that the Ducks skate on each day.

The ice inside a hockey rink is a gigantic piece of ice measuring 200-feet by and 85-feet. Many thin layers of water are frozen on top of each other until the body of ice reaches a thickness of about an inch. After the first few layers of ice are formed, the ice engineer adds a white coating to the surface with a special paint made to withstand cold temperatures. Then, tools such as stencils, compasses, and string are used to draw the most precise lines and shapes for hockey. These graphics are then sealed into place with more layers of water and ice. Check out the graphic to the right for a look at all these different layers!

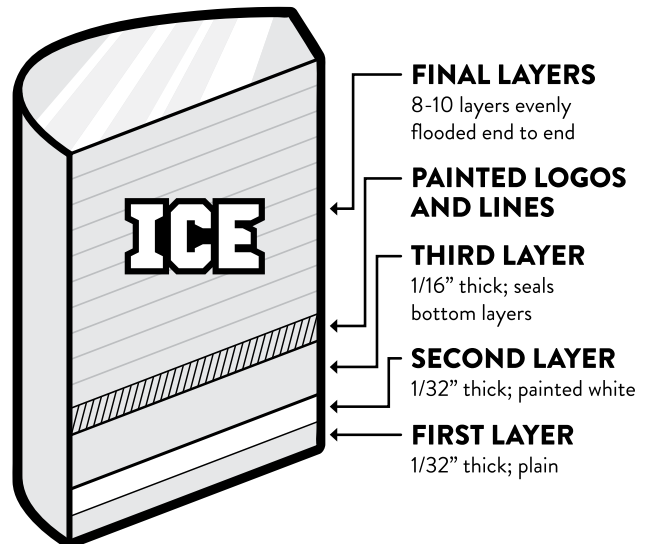



# BENEATH THE SURFACE



## COACHES CHALLENGE

Label the drawings on a hockey rink with their correct name. Read their descriptions below and use your knowledge of basic shapes to complete this activity.

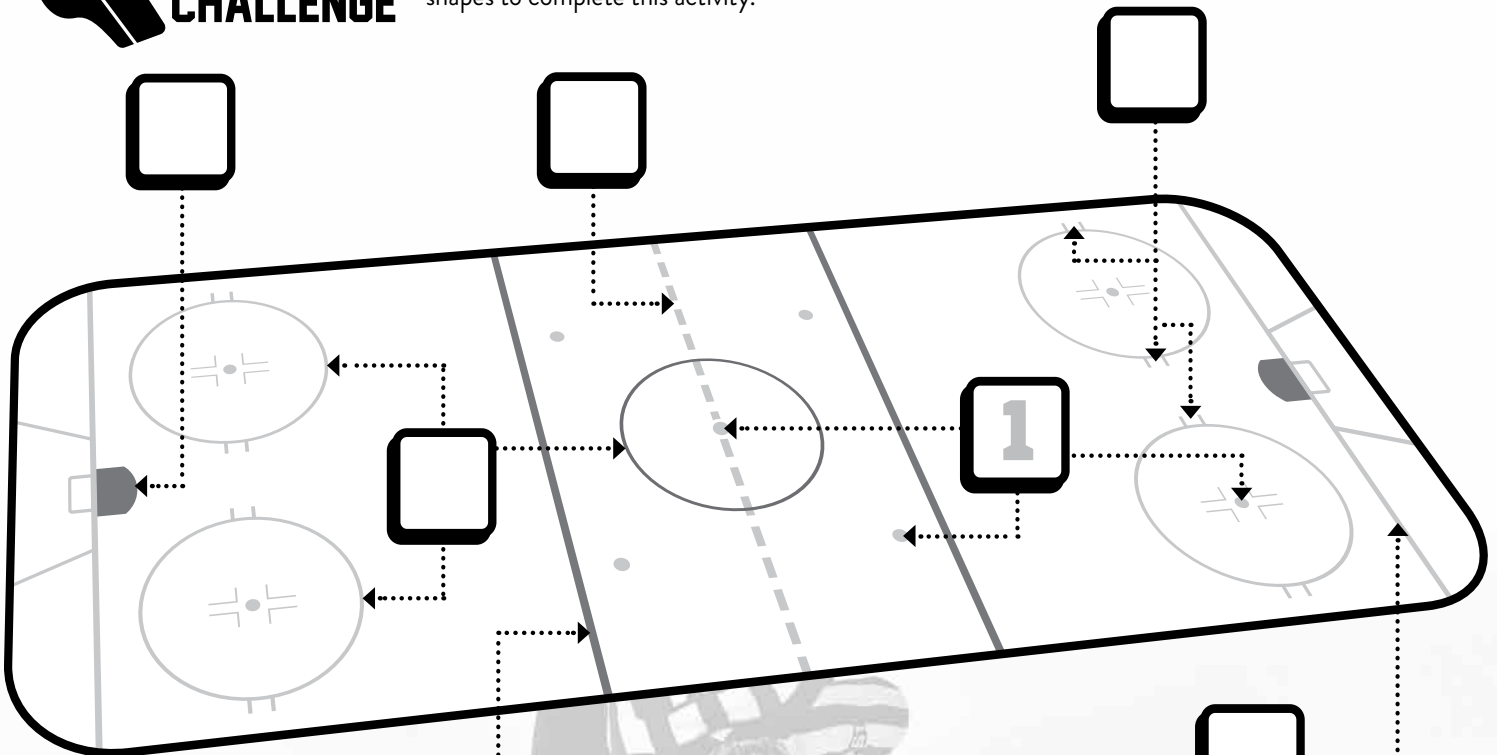

**1 Face-Off Spots**  
Nine small circles where the puck is dropped for a face off

**2 Face-Off Circles**  
Five large circles where the players line up for a face off

**3 Center Ice Line**  
A red line across the width of the ice that divides the rink into two halves

**4 Goal Lines**  
A red line that stretches out to the width of the rink and runs parallel to the center ice line

**5 Goal Crease**  
The blue area in front of each goal that has a shape of a rectangle attached to a semi-circle

**6 Blue Lines**  
A blue line located on each side of the center ice line

**7 Hash Marks**  
Two pairs of perpendicular lines near the face-off spots where the players taking the face off must stand

# BENEATH THE SURFACE

## COACHES CHALLENGE

Building an ice rink starts from the bottom up. Now that you know what's beneath the surface, it's time to make your very own ice rink using the same know-how as the Honda Center ice engineer. Don't skip out on building this rink because you'll need it later!

### STEP 1 GATHER MATERIALS

- Baking Tin
- Water
- Sheet of White Paper
- Crayon or Markers
- Ruler
- Scissors
- Cup
- Spray Bottle

### STEP 2 MAKE THE FIRST LAYER

Fill the baking tin with enough water so that it has a depth of 1/8". Use your ruler to measure the water level.

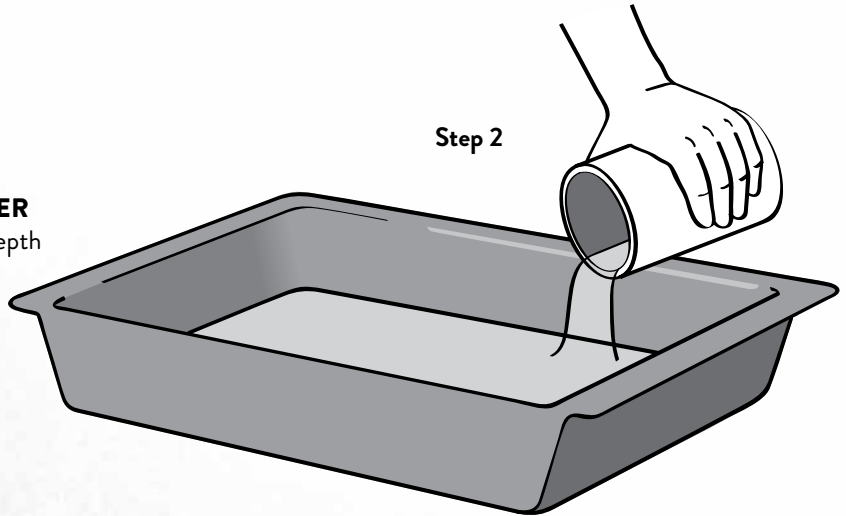

### STEP 3 FREEZE THE ICE

Place the baking tin onto a flat surface in your freezer. It should take a couple of hours for the water to turn into ice.

### STEP 4 DESIGN YOUR RINK

Draw the ice rink graphics (lines, circles, and spots) on your sheet of paper. You can even add a Ducks logo to match the center ice graphic at Honda Center. Use tools, like a ruler, to help you draw the straight lines and circles accurately. Go to page 17 for a reminder of what these rink graphics look like.

### STEP 5 "PAINT" THE ICE

Remove the baking tin from the freezer. Then, add a thin layer of water to your rink using your spray bottle. Lay your rink graphics on top of the ice, spraying more water if the sheet of paper doesn't stick to the surface well enough. Place the rink back into the freezer once you're done.

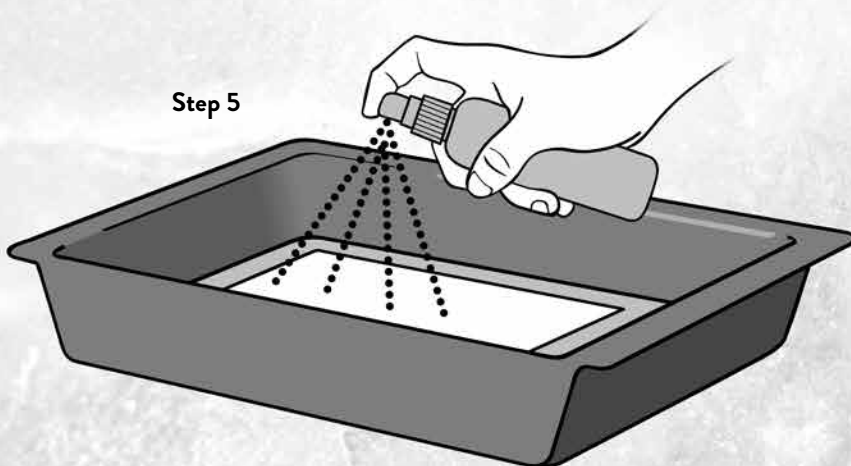

### STEP 6

#### CREATE LAYERS OF ICE

Once the layer of water has frozen, add another thin layer of water using your spray bottle. Keep repeating this step until the ice reaches a thickness of one inch.

### STEP 7

#### YOUR RINK IS DONE!

Take some time to enjoy your creation. Then, put it back into the freezer because you'll need it for the final activity.





# BENEATH THE EARTH'S SURFACE

Presented by



COUNTY OF ORANGE

Waste & Recycling

Our Community. Our Commitment.

## THINK OUTSIDE THE RINK!

We've been learning about the hockey rink, the ice and how it's made up of frozen layers of water. If we walk outside the rink and take a look around we can see the earth's surface. The Earth's surface is the outer layer of our planet, and it's where all living things like people, plants, and animals live. It's also called the crust. This layer is like the "skin" of the Earth, and even though it seems thick, it's actually very thin compared to the other layers inside the Earth.

Just like we resurface the ice, we can resurface that earth. How?! By composting! Composting is a natural process where we turn things like food scraps, yard waste, and other organic materials into rich soil amendment. Instead of throwing away things like fruit peels, vegetable scraps, coffee grounds, and leaves, we put them in a compost pile or curbside organics cart. Over time, these materials break down with the help of tiny organisms like bacteria and worms, turning into a dark, soil-like material called compost.

## WHY COMPOSTING IS IMPORTANT...

- 1 REDUCES WASTE:**  
By composting, we throw away less garbage, so there's less waste in landfills.
- 2 HELPS PLANTS GROW:**  
Compost is full of nutrients that plants love. It can be added to gardens to help plants grow healthy and strong.
- 3 GOOD FOR THE ENVIRONMENT:**  
Composting reduces harmful gases created when food waste rots in landfills, helping keep our air cleaner.



*Anaheim Ducks players volunteer during the season to help upgrade playgrounds and school gardens with fresh compost and mulch!*



# SLIDE SCIENCE

## A SLIPPERY SURFACE

There's no moment that's more satisfying for ice engineers than sitting in a quiet arena with a newly made ice surface that's clear, smooth, and at the perfect temperature for hockey. But, their work is not done yet, because the Anaheim Ducks will be playing a game on this rink soon. Beating heat transfer and making clear ice were difficult challenges to overcome, but there's another challenge up next that will be the toughest one of all. That's friction!

## OPPOSING FORCES

The slipperiness of an object depends on friction. Friction is the force that opposes motion, and it occurs when two objects touch. For hockey, players rely on ice's slippery properties to do amazing things for their fans. While hard hits and puck-handling skills are certainly exciting, it's the blazing speed of the players and the puck that really makes the fans cheer. Ice engineers ensure that their ice surface is smooth to help pucks and ice skates slide across them without any push back. What would happen if friction was the first star of the game? Hockey played on an ice surface full of bumps and rough patches would slow down the action on the ice. This type of hockey wouldn't be fun to watch at all!

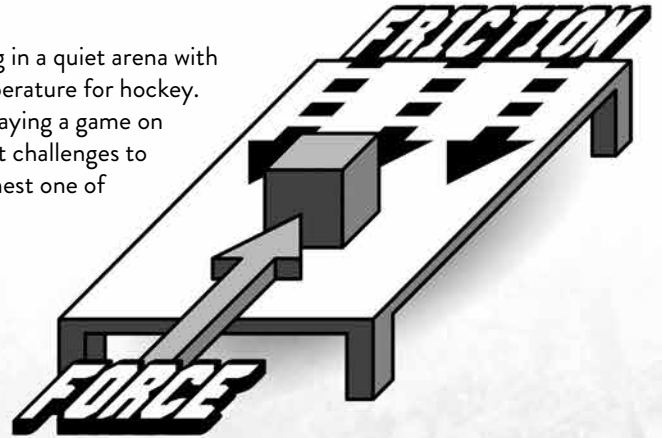

## COACHES CHALLENGE

Friction can be helpful at times, but that's not the case when objects

must move with speed. How would hockey change if the puck had to slide across blacktop, carpet, sandpaper, and wood? Rank these surfaces, 1 through 5, by comparing their amounts of friction. Give a "1" to the surface with the MOST friction and a "5" with the LEAST. Is ice the best surface for hockey? It's time to find out.

FOCUS ON FRICTION		
Surface	Predicted Rank (1-5)	Performance Rank (1-5)
CARPET		
BLACKTOP		
WOOD		
SANDPAPER / OTHER		
ICE		



# SLIDE SCIENCE

## COACHES CHALLENGE

Let's experience friction in real life! Slide a puck across different surfaces to see which one gives the most push back. All you'll need is your rink, a few common items, and the best tools you've got... your hands!

### STEP 1 GATHER MATERIALS

- A Small, Puck-Shaped Object
- Two Large Surfaces
- Your Ice Rink
- Ruler
- Rubber Band
- Plastic Card
- Spray Bottle
- Sponge
- Metal Fork and Spoon

### STEP 2 EXAMINE YOUR SURFACES

Use the chart below to describe the two surfaces (#1 and #2) that you selected. Did you choose to use carpet or a wood table top? You're going to slide a puck across them soon, so get ready!

#	Surface	Description	Distance
1			
2			
3			
4			

### STEP 3 BUILD YOUR SHOOTER

You'll need to make a device that will slide your puck with the same force each time. Use your hands and a ruler for this puck shooter. Practice shooting your puck a few times before moving on to the real thing. Make sure you pull back on the puck about one or two inches from the starting point.

### STEP 4 SHOOT YOUR PUCK

**Surface #1 & #2:** Slide your puck across the two surfaces and measure the distance travelled by it after each trial. Enter these numbers into your chart.

**Surface #3:** Slide your object across your ice surface making sure that it's shot with the same force as the other trials. Measure the distance travelled by the puck and enter it into the chart.

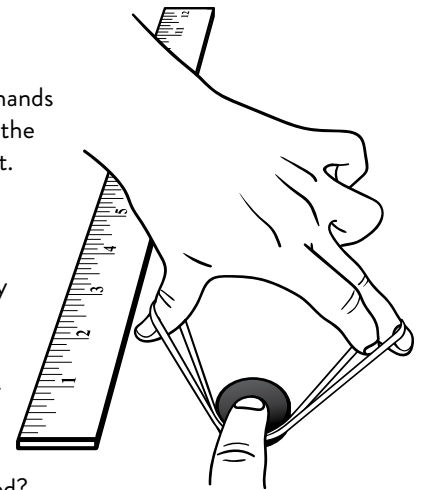

### CONCLUSIONS

1. On which surface did the puck travel the furthest distance? Why do you think this happened?

---

2. On which surface did the puck travel the shortest distance? Why do you think this happened?

---



What would you do to improve your puck shooter? Use your journal and the engineering design process to come up with some ideas. Then, go and make it!

# SLIDE SCIENCE

## RESURFACED

You've just experienced first-hand why ice is the best surface for hockey. It's one of the most slippery objects on Earth because of a thin layer that sits on top of it called "quasi-liquid." It allows hockey players and hockey pucks to slide with little to no friction. Unfortunately, for ice engineers, the ice surface loses its frictionless properties after each 20-minute period of a hockey game. Every time a player moves left, right, or stops on a dime, their skate blades dig deep into the ice. Their movement scatters a bunch of snow on to the ice surface and makes it rough and bumpy. Hockey isn't as exciting to watch with this type of surface because it affects the speed of the game. The puck moves a lot slower when this happens.



Using your journal, jot down some answers for each of the discussion questions below:

1. List some problems that might happen during a hockey game when the Ducks skate, pass, and shoot on an ice rink that's rough, bumpy, and filled with snow.
2. If you were an ice engineer, what would you do to turn a choppy ice rink back to its slippery state? What tools would you use to help you achieve this goal?

Fortunately, ice engineers around the NHL have a large crew and many resources to return the ice back to its original, slippery state. This 20-person crew is used during timeouts to fix deep cuts in the ice and to remove snow scattered by the players. However, these things are only temporary fixes. That's why hockey games have two 18-minute intermissions in between periods. While players rest during this time, ice engineers and their crew are hard at work returning the choppy ice surface back to its original state. In addition to using hand tools, heavy machinery is brought in to do the job so that friction won't be a problem when the Ducks return from their long break.

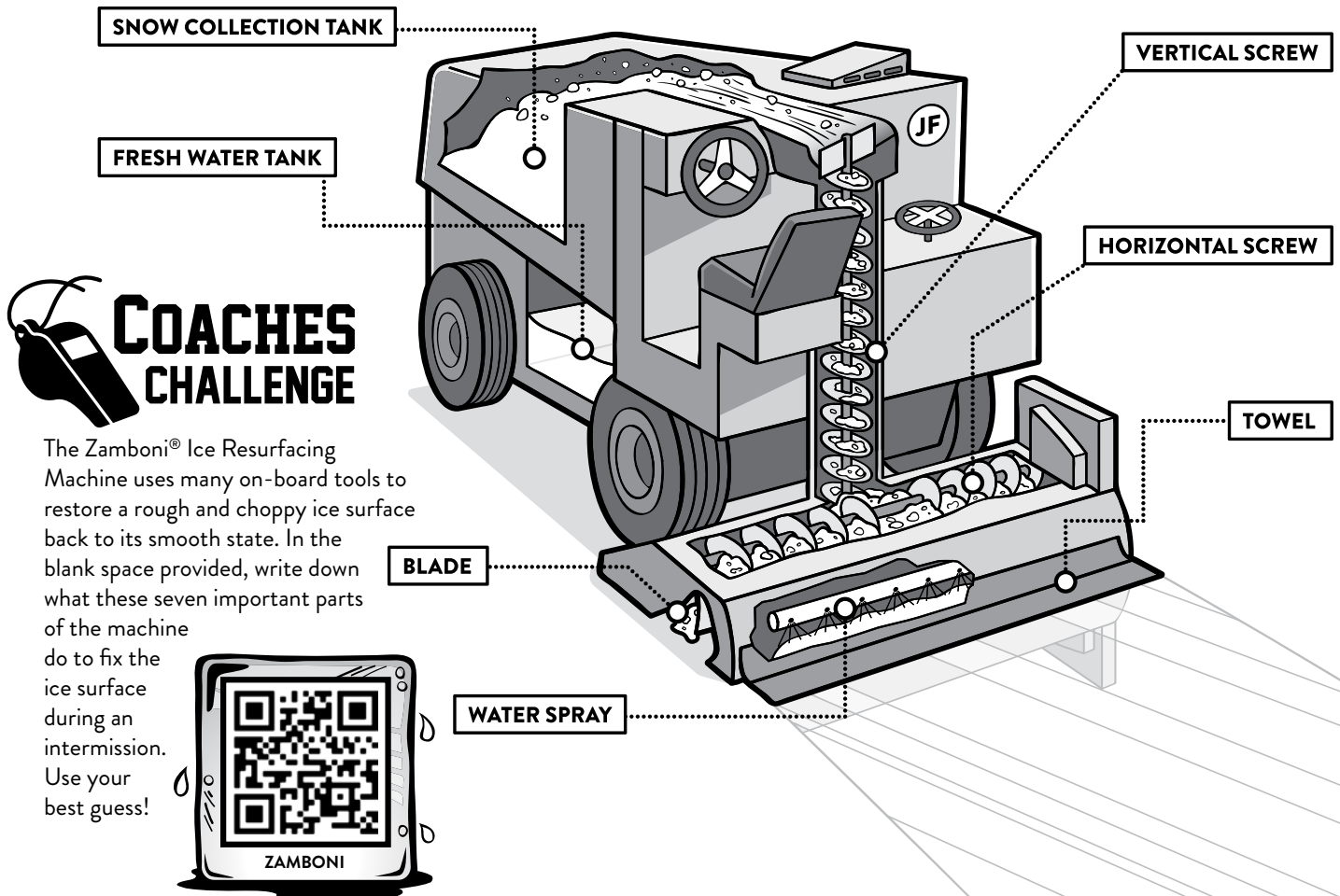



# SLIDE SCIENCE

## STEP 5 SKATE ON YOUR RINK

Create a choppy surface by “skating” on your ice rink. Use a fork to rough up the surface, not stopping until the rink is full of skate marks and snow. Shoot your puck across this new surface (#4) and measure the distance it travelled. Enter the figure into row #4 of the chart found on page 20.

## STEP 6 FIX YOUR ICE RINK!

Since most people don't have access to a 3-ton ice resurfacing machine at home, use the following steps to turn this rough and bumpy ice surface back to a frictionless one!

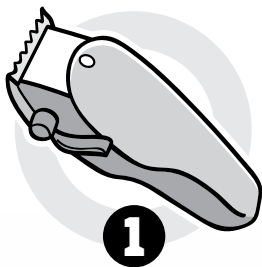

1

### “CUT” THE ICE

Scrape the ice surface with the edge of the plastic card to shave off the top layer of snow and ice bits. Start from the wall closest to you and slide the card to the opposite end. Keep doing this until you have “shaved” the entire width of the rink.

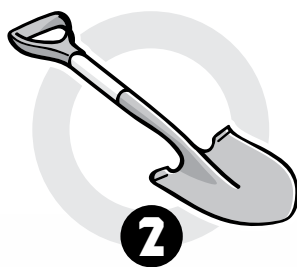

2

### COLLECT THE ICE

Use a spoon to collect (or scoop) the snow and remove it from the rink.



3

### “FLOOD” THE ICE

Cover the ice surface with a thin layer of water using your spray bottle. Hold the bottle at least one foot above the rink. Spraying too closely might create more holes in the ice! Make sure to fill any gaps or holes with water.

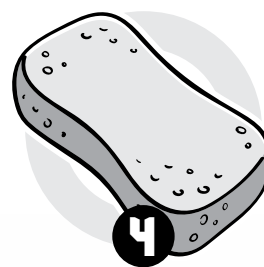

4

### SMOOTH THE ICE

Soak the sponge in a bowl of warm water. Gently ring out the excess water and use it to smooth out any bumps on the ice surface. Give your rink one last spray and you're done!



5

### FREEZE THE ICE

Place the rink back into the freezer. After 30 minutes, it should be back to its slippery self.

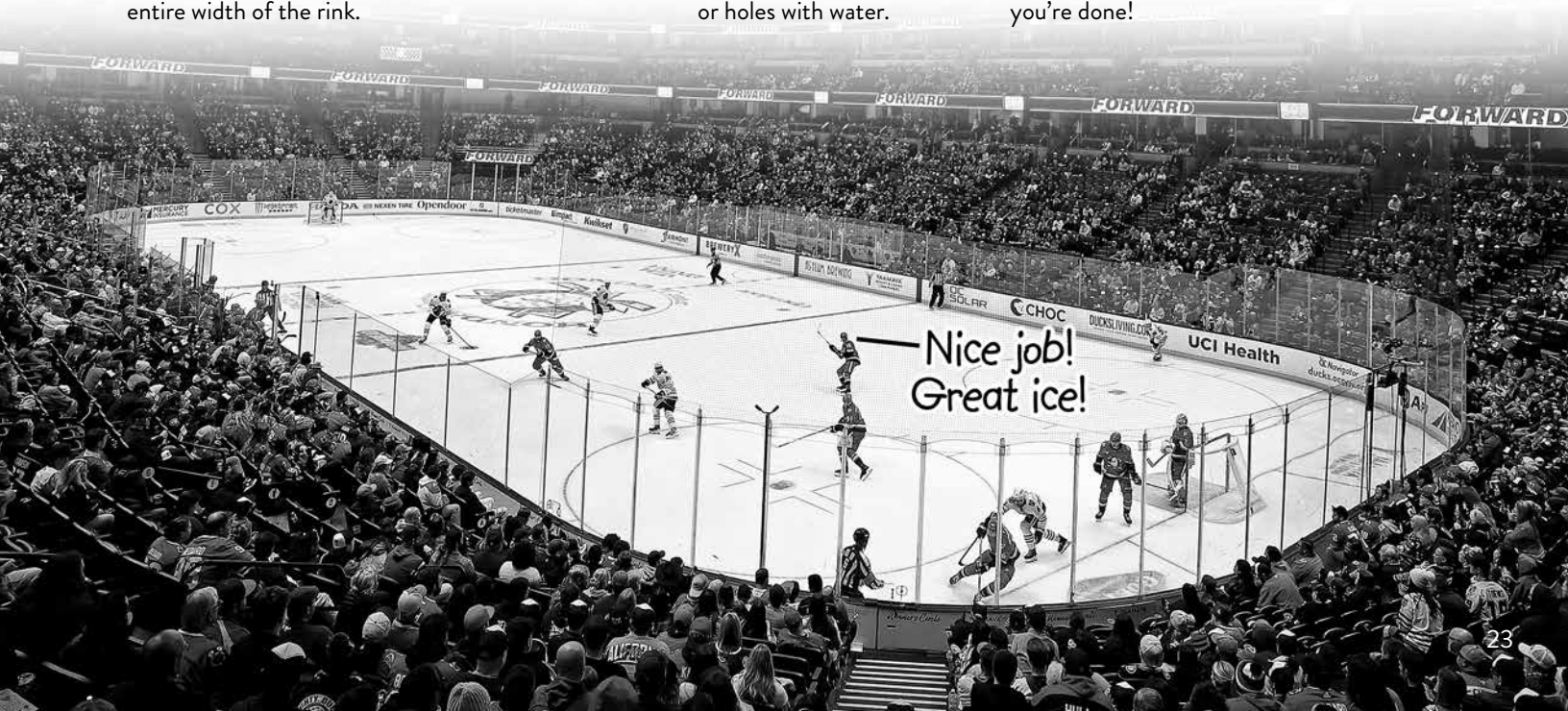



# SLIDE SCIENCE

## CONCLUSIONS

1. Explain what a Zamboni® Ice Resurfacing Machine is used for in a hockey game.

---

---

2. Explain how a Zamboni® Ice Resurfacing Machine returns the ice back to its original state.

---

---

3. What are some ways friction can be helpful to you?

---

---



1. Now that you've resurfaced an ice rink with your own hands, go back to page 21 and revise your original answers about how the ice resurfacing machine works.
2. What would you do to improve this ice-fixing activity? Use your journal and the engineering design process to come up with some ideas. Then, go and make it!

**YOU'VE  
DONE IT!**  
*You're an ice engineer.  
Welcome to our team!*



*Honda Center  
Ice Crew*





# HOCKEY HOMEWORK

## WHAT DO YOU NOTICE

While you're at Honda Center, spend some time looking around. What do you notice?

Describe the ice rink at Honda Center. What does the surface look like? Is it smooth or rough?

---

---

---

How many players are on the ice?

---

---

---

Can you identify which ones are the goalies? Describe what the goalies look like.

---

---

---



# HOCKEY HOMEWORK

## DID YOU KNOW?

The blades on the players skates are hollow. Each player sharpens their skates to the specific hollow radius they prefer. Sharp skates and personalized hollows allow players to stop quickly and turn sharply, sometimes even on one foot!

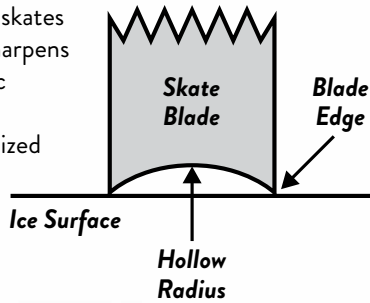

Look closely at the Ducks players as they shoot, pass, and stickhandle the puck. Describe what you see.

---

---

---

---

---

---

---

---

---

---

Does the ice look different the longer practice goes on?

---

---

---

---

---

---

---

---

---

---

What questions would you ask the Anaheim Ducks players?

---

---

---

---

---

---

---

---

---

---

When players stop hard, they dig into the ice which causes **snow to fly into the air!**



# HOCKEY HOMEWORK

## I SPY – FROM MY SEAT!

How many banners hang from the rafters? \_\_\_\_\_

How many Ducks logos  can you find in the arena? \_\_\_\_\_

What does the temperature feel like? Do you think it is colder or warmer with all the fans in their seats?

---

---

From where you're sitting, can you find the two flags in the building? What countries do they represent? Can you guess why those two countries are represented?

Flag 1: \_\_\_\_\_

Flag 2: \_\_\_\_\_

Do you see a "Stanley Cup Championships" banner? What year is written on that banner?

---

Were you born before or after the Anaheim Ducks became Stanley Cup Champions? (*Hint: The Ducks won June 6th, 2007.*)

---

Can you come up with your own team **HOCKEY** names?

Hawks (example) \_\_\_\_\_

O \_\_\_\_\_

C \_\_\_\_\_

K \_\_\_\_\_

E \_\_\_\_\_

Y \_\_\_\_\_

Hmmm, I wonder how many students are in Honda Center right now.



Sad you've completed the First Flight workbook? Don't be! Continue the fun learning at Discovery Cube! Scan here for more information!



DiscoveryCube



Teachers, book your class a field trip **starting at just \$11 per student!**



PRESENTED BY  
CHOC | UCI Health

# OFFICIAL SOUVENIR OF THE FIRST FLIGHT FIELD TRIP

TAKE HOME A WILD WINGS KIDS CLUB KIT

ORDER NOW FOR THE  
SPECIAL PRICE OF **\$25**



FOR MORE INFORMATION, PLEASE CONTACT [KIDSCLUB@ANAHEIMDUCKS.COM](mailto:KIDSCLUB@ANAHEIMDUCKS.COM)  
TO ORDER, VISIT: [ANAHEIMDUCKS.COM/FIRSTFLIGHTKIDSCLUB](http://ANAHEIMDUCKS.COM/FIRSTFLIGHTKIDSCLUB)



# THE ANAHEIM DUCKS WOULD LIKE TO THANK THE FOLLOWING FOR THEIR SUPPORT OF THE FIRST FLIGHT FIELD TRIP



## FUTURE GOALS™

POWERED BY EVERFI



### CHOC

LONG LIVE CHILDHOOD



ANAHEIM DUCKS  
FOUNDATION



COUNTY OF ORANGE  
**OC Waste & Recycling**  
Our Community. Our Commitment.





ANAHEIM DUCKS  
**FOUNDATION**